

Klipsch® NASHVILLE

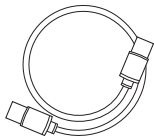

INSIDE

CONTENU • CONTENIDO • INHALT • CONTENUTO • CONTEÚDO • 目录 • 同梱品 • 裡面 • 내부

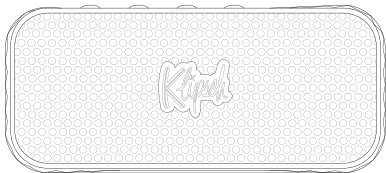

BUTTONS

CONTENU • CONTENIDO • INHALT • CONTENUTO • CONTEÚDO • 目录 • コントロール • 按鈕 • 버튼

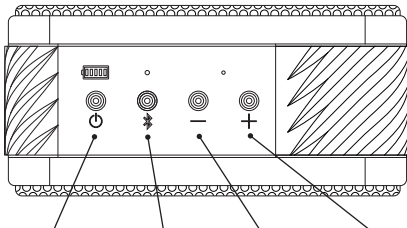

ON / OFF	Bluetooth®	Volume Down	Volume Up
Sous tension w /Hors tension	Bluetooth®	Volume bas	Volume haut
Encendido / Apagado	Bluetooth®	Bajada de volumen	Subida de volumen
Ein / Aus	Bluetooth®	Leiser	Lauter
Acceso / Spento	Bluetooth®	Riduzione volume	Aumento volume
Ligar / Desligar	Bluetooth®	Diminuir o volume	Aumentar o volume
开/关	蓝牙®	音量减小	音量增大
電源オン/オフ	Bluetooth®	音量ダウン	音量アップ
開 / 關	藍牙	降低音量	提高音量
전원	블루투스	음량 감소	음량 증가

BATTERY CHARGE

CHARGE BATTERIE • CARGA DE LA PILA • AKKULADESTAND • CARICA BATTERIA • CARGA DA BATERIA • 電池充電 •
チャージ • 電池充電 • 배터리 충전

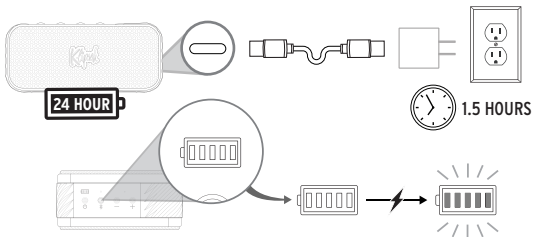

USB REVERSE CHARGING

CHARGE INVERSÉE USB • CARGA INVERSA POR USB • USB-ANSCHLUSS MIT BIDIREKTIONALER LADEFUNKTION •
RICARICA INVERSA CON LA PORTA USB-C • CARREGAMENTO REVERSO VIA USB • USB 接口可为其他设备充电 •
USB逆充電 • USB 反向充電 • USB 역충전

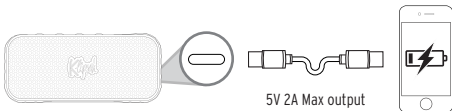

BLUETOOTH® WIRELESS TECHNOLOGY

TECNOLOGÍA INALÁMBRICA **BLUETOOTH®** • CONFIGURACIÓN DE TECNOLOGIA WIRELESS **BLUETOOTH®** •
DRAHTLOSE **BLUETOOTH®**-TECHNOLOGIE-SETUP • CONFIGURAZIONE TECNOLOGIA WIRELESS **BLUETOOTH®** •
CONFIGURAÇÃO DE TECNOLOGIA SEM FIO **BLUETOOTH®** • **BLUETOOTH®** 蓝牙无线电子技术 •
BLUETOOTH® ワイヤレス技術 • **BLUETOOTH®** 藍牙無線技術 • **BLUETOOTH®** 무선 기술

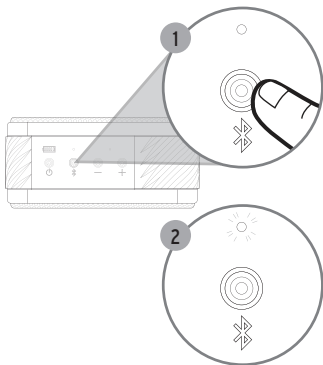

Hold 3 Seconds

Appuyer pendant 3 secondes
Mantenga oprimido durante 3 segundos
3 Sekunden gedrückt halten
Tenere premuto per 3 secondi
Manter pressionado por 3 segundos
长按 3 秒
3秒間押します
保持 3 秒
3초 간 누른다

Flashing

Clignotant	闪烁
Destello	点滅
Blinkt	閃爍
Lampeggiante	점멸
Intermittente	

*** Example only. Your device may differ.**

• À titre d'exemple seulement. Votre appareil peut être différent. • Este es solo un ejemplo. Es posible que su dispositivo sea diferente. • Nur als Beispiel. Ihr Gerät kann anders aussehen. • Solo a titolo esemplificativo. Lo specifico dispositivo può essere diverso. • Apenas para exemplo. O dispositivo pode ser diferente. • 仅为示例。实际设备可能有所不同。例のみ:デバイスによって異なります • 僅供參考。您的設備可能有所不同。 • 예입니다. 제품마다 다를 수 있습니다.

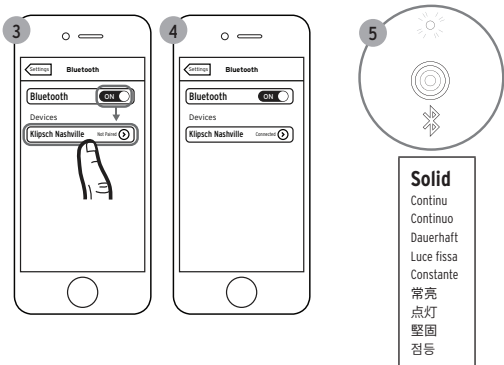

TRUE WIRELESS STEREO PAIRING

VÉRITABLE COUPLAGE STÉRÉO SANS FIL • VERDADERO EMPAREJAMIENTO ESTÉRÉO INALÁMBRICO • ECHE KABELLOSE STEREO-KOPPLUNG • VERO ACCOPPIAMENTO STEREO WIRELESS • EMPARELHAMENTO ESTÉRÉO SEM FIO VERDADEIRO

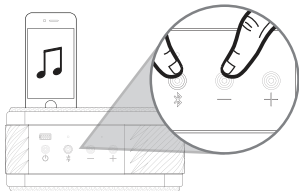

Hold <1 Seconds

Appuyer pendant <1 secondes
Mantenga oprimido durante <1 segundos
<1 Sekunden gedrückt halten
Tenere premuto per <1 secondi
Manter pressionado por <1 segundos
保持 <1 秒
<1秒間押します
<1초 유지

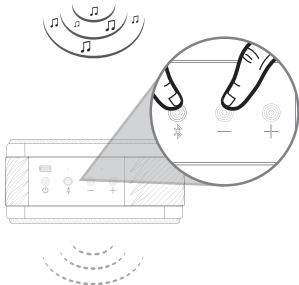

Hold <1 Seconds

Appuyer pendant <1 secondes
Mantenga oprimido durante <1 segundos
<1 Sekunden gedrückt halten
Tenere premuto per <1 secondi
Manter pressionado por <1 segundos
保持 <1 秒
<1秒間押します
<1초 유지
點按 <1秒
1초 이하로 누른다

真正的无线立体声配对 • 完全ワイヤレスステレオペアリング • 真正的無線立體聲配對
진정한 무선 스테레오 페어링

Flashing White

Blanc clignotant

Destello blanco

Weiß blinkend

Bianco Lampeggiante

Branco Intermitente

闪烁白色

白く点滅

白色閃爍

흰색 점멸

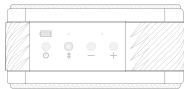
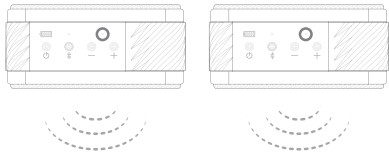

L

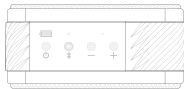

R

BROADCAST MODE PAIRING

COUPLAGE EN MODE DIFFUSION • VINCULACIÓN EN MODALIDAD DE EMISIÓN • ÜBERTRAGUNGSMODUS-KOPPLUNG • ASSOCIAZIONE IN MODALITÀ BROADCAST • PAREAMENTO PELO MODO BROADCAST • 广播模式配对

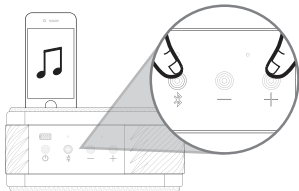

Hold >1 Seconds

Appuyer pendant >1 secondes
Mantenga oprimido durante >1 segundos
>1 Sekunden gedrückt halten
Tenere premuto per >1 secondi
Manter pressionado por >1 segundos
保持 >1 秒
>1秒間押します
>1초 유지

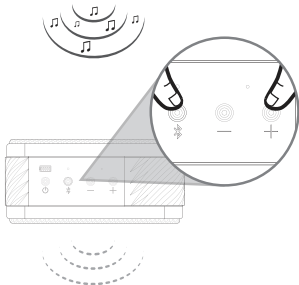

Hold >1 Seconds

Appuyer pendant >1 secondes
Mantenga oprimido durante >1 segundos
>1 Sekunden gedrückt halten
Tenere premuto per >1 secondi
Manter pressionado por >1 segundos
保持 >1 秒
>1秒間押します
>1초 유지

Flashing White

Blanc clignotant

Destello blanco

Weiß blinkend

Bianco Lampeggiante

Branco Intermitente

闪烁白色

白く点滅

白色閃爍

흰색 점멸

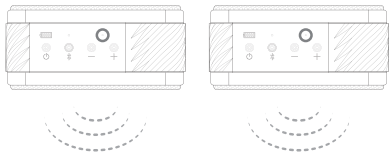

CARE AND CLEANING

ENTRETIEN ET NETTOYAGE • CUIDADO Y LIMPIEZA • PFLEGE UND REINIGUNG • CURA E PULIZIA •
CUIDADOS E LIMPEZA • 保养与清洁 • お手入れ • 護理和清潔 • 관리 및 청소

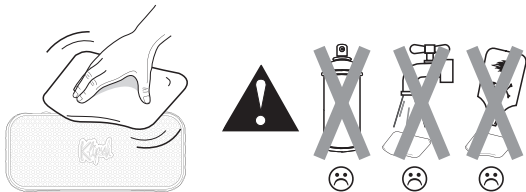

FACTORY RESET

RÉINITIALISATION • RESTABLECIMIENTO DE FÁBRICA • RÜCKSETZUNG AUF WERKSEINSTELLUNG • RIPRISTINO
IMPOSTAZIONI DI FABBRICA • RESTABELECIMENTO DAS CONFIGURAÇÕES DE FÁBRICA • 恢复出厂设置
工場出荷時設定 • 공장초기화

